

UNIVERSAL & HUNTING GATES

Treated Softwood

Width	Stock No	Price
900mm	1105000	£ 83.00
1200mm	1105001	£ 88.00
1500mm	1105002	£ 99.00
1800mm	1105003	£106.00
2100mm	1105004	£115.00

Width	Stock No	Price
2400mm	1105005	£125.00
2700mm	1105006	£132.00
3000mm	1105007	£138.00
3300mm	1105008	£146.00
3600mm	1105009	£150.00

Sapele

900mm	1900100	£120.00
1200mm	1900101	£130.00
1500mm	1900102	£140.00
1800mm	1900103	£170.00
2100mm	1900104	£188.00

2400mm	1900105	£206.00
2700mm	1900106	£222.00
3000mm	1900107	£239.00
3300mm	1900108	£253.00
3600mm	1900109	£260.00

Iroko

900mm	1500100	£144.00
1200mm	1500101	£157.00
1500mm	1500102	£168.00
1800mm	1500103	£204.00
2100mm	1500104	£225.00

2400mm	1500105	£247.00
2700mm	1500106	£267.00
3000mm	1500107	£287.00
3300mm	1500108	£303.00
3600mm	1500109	£312.00

ALBION GATE

Width	Stock No	Price
900mm	1000301	£ 50.00
1200mm	1000302	£ 58.00
1500mm	1000303	£ 67.00
1800mm	1000304	£ 73.00
2100mm	1000305	£ 80.00
2400mm	1000306	£ 89.00

Width	Stock No	Price
2700mm	1000307	£ 94.00
3000mm	1000308	£ 99.00
3300mm	1000309	£103.00
3600mm	1000310	£105.00
3900mm	1000311	£132.00
4200mm	1000312	£144.00

GLOSSARY

Treated Softwood

We use good quality European and Scandinavian softwoods. The components are selected, machined and finally treated to ensure that the joints are properly preserved. Some splitting or cracks may occur, especially in periods of hot weather.

Sapele

Sapele is a durable industrial quality hardwood with a mahogany colour. For all applications where a tough utilitarian hardwood is required. It's appearance and longevity will benefit from a coat or two of preservative or alternatively will readily accept a painted finish. Some splitting or cracks may occur especially in periods of hot weather, this does not generally affect the strength and durability of the gates and is therefore not seen as a defect.

Iroko

Iroko is a top quality hardwood, yellowish brown in colour and similar to teak in its texture and properties. Makes a superb entrance gate. Very durable. Use Sikken's or Sadolins to preserve the colour. The most resistant to splitting or cracking.

Non standard width

Add £10.00 on to next size up. (This does not apply to Albion gates).

Standard Gate Sizes – Width

mm	900	1200	1500	1800	2100	2400	2700	3000	3300	3600
feet	2'11 1/2"	3'11 1/4"	4'11"	5'11"	6'10 1/2"	7'10 1/2"	8'10 1/4"	9'10"	10'9 3/4"	11'9 3/4"

Standard Gate Sizes – Height

The o/a height of the gates is 1195mm (47") apart from the Yeoman which is: standard 1700mm (67")

small 1300mm (51 1/4")

KENT GATE**Treated Softwood**

Width	Stock No	Price
900mm	1200010	£ 89.00
1200mm	1200011	£ 94.00
1500mm	1200012	£104.00
1800mm	1200013	£115.00
2100mm	1200014	£123.00

Width	Stock No	Price
2400mm	1200015	£131.00
2700mm	1200016	£137.00
3000mm	1200017	£144.00
3300mm	1200018	£150.00
3600mm	1200019	£155.00

Sapele

900mm	1900110	£124.00
1200mm	1900111	£138.00
1500mm	1900112	£158.00
1800mm	1900113	£180.00
2100mm	1900114	£194.00

2400mm	1900115	£213.00
2700mm	1900116	£224.00
3000mm	1900117	£236.00
3300mm	1900118	£248.00
3600mm	1900119	£260.00

Iroko

900mm	1500110	£149.00
1200mm	1500111	£166.00
1500mm	1500112	£190.00
1800mm	1500113	£216.00
2100mm	1500114	£233.00

2400mm	1500115	£255.00
2700mm	1500116	£269.00
3000mm	1500117	£283.00
3300mm	1500118	£298.00
3600mm	1500119	£312.00

SUSSEX GATE**Treated Softwood**

Width	Stock No	Price
900mm	1200020	£111.00
1200mm	1200021	£124.00
1500mm	1200022	£133.00
1800mm	1200023	£139.00
2100mm	1200024	£147.00

Width	Stock No	Price
2400mm	1200025	£168.00
2700mm	1200026	£173.00
3000mm	1200027	£179.00
3300mm	1200028	£186.00
3600mm	1200029	£191.00

Sapele

900mm	1900120	£144.00
1200mm	1900121	£163.00
1500mm	1900122	£185.00
1800mm	1900123	£199.00
2100mm	1900124	£213.00

2400mm	1900125	£249.00
2700mm	1900126	£263.00
3000mm	1900127	£275.00
3300mm	1900128	£288.00
3600mm	1900129	£300.00

Iroko

900mm	1500120	£173.00
1200mm	1500121	£195.00
1500mm	1500122	£223.00
1800mm	1500123	£239.00
2100mm	1500124	£256.00

2400mm	1500125	£299.00
2700mm	1500126	£315.00
3000mm	1500127	£330.00
3300mm	1500128	£345.00
3600mm	1500129	£361.00

WEALDEN GATE**Treated Softwood**

Width	Stock No	Price
900mm	1200030	£137.00
1200mm	1200031	£158.00
1500mm	1200032	£171.00
1800mm	1200033	£188.00

Width	Stock No	Price
2100mm	1200034	£197.00
2400mm	1200035	£206.00
Not available above 2400mm		

Sapele

900mm	1900130	£172.00
1200mm	1900131	£199.00
1500mm	1900132	£229.00
1800mm	1900133	£257.00

2100mm	1900134	£276.00
2400mm	1900135	£296.00
Not available above 2400mm		

Iroko

900mm	1500130	£206.00
1200mm	1500131	£239.00
1500mm	1500132	£275.00
1800mm	1500133	£308.00

2100mm	1500134	£331.00
2400mm	1500135	£355.00
Not available above 2400mm		

All Prices Subject to VAT

YEOMAN GATES

Treated Softwood

Width	Stock No	Price
900mm	1200040	£137.00
1200mm	1200041	£150.00
1500mm	1200042	£156.00
1800mm	1200043	£233.00
2100mm	1200044	£241.00

Width	Stock No	Price
2400mm	1200045	£247.00
2700mm	1200046	£254.00
3000mm	1200047	£262.00
3300mm	1200048	£267.00
3600mm	1200049	£273.00

Sapele

900mm	1900140	£176.00
1200mm	1900141	£193.00
1500mm	1900142	£208.00
1800mm	1900143	£305.00
2100mm	1900144	£320.00

2400mm	1900145	£334.00
2700mm	1900146	£347.00
3000mm	1900147	£365.00
3300mm	1900148	£378.00
3600mm	1900149	£390.00

Iroko

900mm	1500140	£211.00
1200mm	1500141	£231.00
1500mm	1500142	£250.00
1800mm	1500143	£366.00
2100mm	1500144	£384.00

2400mm	1500145	£401.00
2700mm	1500146	£416.00
3000mm	1500147	£438.00
3300mm	1500148	£453.00
3600mm	1500149	£469.00

Equestrian Gates & Fittings

	Stock No	Price
With Cill	1001051	£288.00
Without Cill	1001052	£250.43

Rambler Pedestrian Gates

Stock No	Price
1001050	£219.00

<u>Standard Stile</u>	1001066	£ 72.34
------------------------------	---------	---------

KISSING GATES

Hardwood

	Stock No	Price
Fencing Section	1001055	£183.52
1200mm Sapele Hunting gate	1900101	£130.00
305mm galv hanging set	1301009	£ 20.36
Hinges fitted to gate	1300049	£ 10.50
Complete		£344.38

Treated Softwood

	Stock No	Price
Fencing Section	1001056	£ 84.12
1200mm Albion gate	1000302	£ 58.00
305mm galv hanging set	1301009	£ 20.36
Hinges fitted to gate	1300049	£ 10.50
Complete		£172.98

*Made in sawn timber comprising 2 no. 1800 x 100 x 150mm and 2 no. 2100 x 150 x 150mm posts weathered and mortised, 6 no. 1200 x 39 x 89mm rails and a 1200mm gate and fittings. Mortised and tenoned.

KISSING GATES

Treated Softwood Only

Fencing Section	1001057	£ 70.20
1200mm Albion gate	1000302	£ 58.00
305mm galv hanging set on 150 x 60mm plates	1301120	£ 27.06
Hinges fitted to gate	1300049	£ 10.50
Complete		£165.76

*Made in treated softwood comprising 2 no. 2100 x 75 x 125mm and 2 no. 2100 x 125 x 125mm posts weathered, 6 no. 1200 x 39 x 89mm rails and a 1200mm gate and fittings. Rails are nailed on to posts (nails not included).

All prices subject to VAT

Posts

Sawn Oak Posts

		Square Tops	
1500 x 75 x 75mm	1403007	£	8.19
1800 x 75 x 75mm	1403009	£	9.83
2100 x 75 x 75mm	1403011	£	11.47
2400 x 75 x 75mm	1403013	£	13.11
2700 x 75 x 75mm	1403015	£	14.75
3000 x 75 x 75mm	1403017	£	16.39
1500 x 100 x 100mm	1403027	£	14.57
1800 x 100 x 100mm	1403029	£	17.48
2100 x 100 x 100mm	1403031	£	20.39
2400 x 100 x 100mm	1403033	£	23.30
2700 x 100 x 100mm	1403035	£	26.22
3000 x 100 x 100mm	1403037	£	29.13

		Weathered Tops	
2100 x 125 x 125mm	1404051	£	34.87
2400 x 125 x 125mm	1404053	£	39.42
2100 x 150 x 150mm	1404071	£	48.89
2400 x 150 x 150mm	1404073	£	55.44
2100 x 175 x 175mm	1404091	£	65.45
2400 x 175 x 175mm	1404093	£	74.38
2400 x 200 x 200mm	1404113	£	96.23

Sawn Treated Softwood Posts

		Square Tops	
1500 x 75 x 75mm	1405007	£	3.38
1800 x 75 x 75mm	1405009	£	4.06
2100 x 75 x 75mm	1405011	£	4.76
2400 x 75 x 75mm	1405013	£	5.42
2700 x 75 x 75mm	1405015	£	6.10
3000 x 75 x 75mm	1405017	£	6.78
1500 x 100 x 100mm	1405027	£	6.02
1800 x 100 x 100mm	1405029	£	7.23
2100 x 100 x 100mm	1405031	£	8.43
2400 x 100 x 100mm	1405033	£	9.64
2700 x 100 x 100mm	1405035	£	10.84
3000 x 100 x 100mm	1405037	£	12.05

		Weathered Tops	
2100 x 125 x 125mm	1406051	£	18.25
2400 x 125 x 125mm	1406053	£	20.81
2100 x 150 x 150mm	1406071	£	22.18
2400 x 150 x 150mm	1406073	£	24.89
2100 x 175 x 175mm	1406091	£	29.68
2400 x 175 x 175mm	1406093	£	33.48
2400 x 200 x 200mm	1406113	£	42.75



Four way weathered



Two way weathered



Round top weathered

Rounded tops available. Price on request.

Some splitting or cracking may occur, particularly in periods of hot weather. However, this is extremely unlikely to lessen the strength of the posts.

All prices subject to VAT

Hanging Your Gates

POSITIONING NEW POSTS

There are two ways to hang a gate – either on the backs of or between the posts. Normally gates are hung on the backs of posts. But some situations require that they should be hung between - so that they open both ways for instance. In either case the posts must be placed accurately according to the width of the gate, and making allowance for the fittings to be used. The diagrams below show how to calculate the distance between the posts with recommended fittings.

N.B. Slightly different arrangements are necessary when either BG rising hinges or an Offset Bottom Hinge set is used.

1. Single gate hung on the backs of posts – gate opens inwards.
Distance between posts = width of gate less 50 mm (2"). Gate overlaps each post by 25mm (1"). Standard hanging sets recommended with either an Auto catch or Spring Fastener.

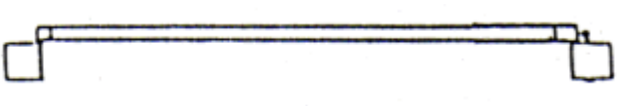

2. Pair of gates hung on back of posts – gate opens inwards.
Distance between posts – combined width of gates less 38 mm (1 1/2"). Gates overlap posts by 25 mm (1"). With 12 mm (1/2") gap between centres. Adjustable Hanging Sets recommended, with a Loopover Fastener and drop bolt(s).

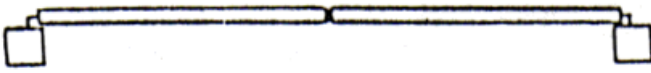

3. Single gate hung between posts – gate opens either way.
Distance between posts = width of gate plus 192 mm (7 1/2") allows 110 mm (4 1/2"). For standard Hanging Set and 82 mm (3 1/2") for Chelsea Catch.

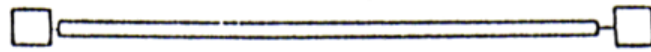

4. Pair of gates hung between posts – gate opens either way.
Distance between posts = combined width of gates plus 241 mm (9 1/2"); allows 110 mm (4 1/2") for each Adjustable Hanging Set, and 12 mm (1/2") gap between gates. Loopover Fasteners and Drop bolt(s) are recommended.

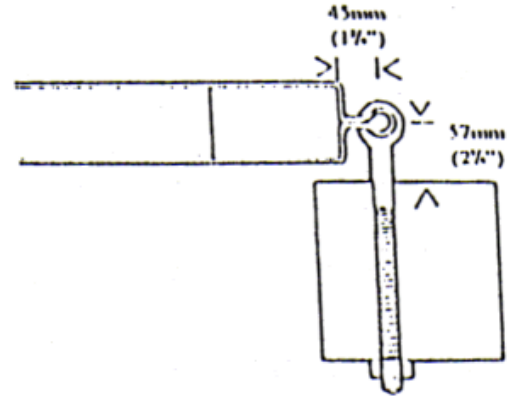

The hook is correctly positioned when there is 57 mm (2 1/4") between centre of the pin and face of the post.

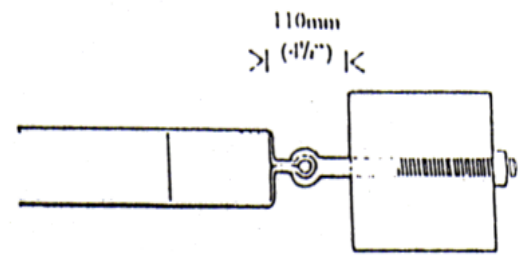

The same applies when hanging between posts, allowing 110 mm (4 1/2") between gate and post altogether.

POSITIONING THE HOOKS IN THE POST

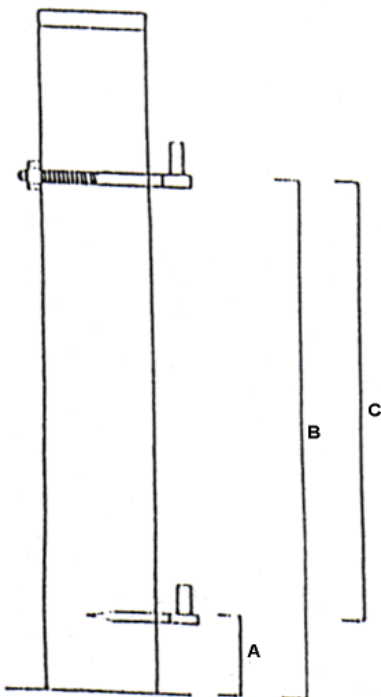

Ideally a gate should hang so that it is about 50 mm (2") off the ground. This height will be determined by the positioning of the hooks in the posts. The correct position for the four basic hanging sets are shown below.

For 305 mm Standard Hanging Set

- A. Lower hook 15 cm (6") from ground
- B. Upper hook 104 cm (41") from ground
- C. Bearing surface distance (i.e. the distance between the upper of the hooks - the faces on which the hinges rest) – 89 cm (35")

For 610 mm Standard Hanging Set

- A. Lower hook 15 cm (6") from ground
- B. Upper hook 101 cm (40") from ground
- C. Bearing surface distance – 86 cm (34")

For 305 mm Adjustable Hanging Set

- A. Lower hook 30 cm (12") from ground
- B. Upper hook 104 cm (41") from ground
- C. Bearing surface distance – 73 cm (29")

For 610 mm Adjustable Hanging Set

- A. Lower hook 30 cm (12") from ground
- B. Upper hook 101 cm (40") from ground
- C. Bearing surface distance – 71 cm (28")

N.B. If the existing hooks are positioned differently from the above, it may be possible to adjust the position of the hinges on the gate to compensate.

FIELD GATE FITTINGS

Stock No	Galvanised		Prices
1301001	Top Ride Hinge	610mm	£ 8.65
1301002	Bottom Ride Hinge	125mm	£ 3.40
1301007	Top Ride Hinge	305mm	£ 7.79
1301008	Bottom Ride Hinge	87mm	£ 3.09
1301102	Adjustable Bottom Hinge		£ 7.94
1301003	Top Hook to Bolt	280mm	£ 5.33
1301005	Top Hook to Bolt	330mm	£ 5.44
1301004	Bottom Hook to Drive	215mm	£ 2.92
1301006	Standard Hanging Set	610mm	£ 22.16
1301009	Standard Hanging Set	305mm	£ 20.36
1301050	Adjustable Hanging Set	610mm	£ 25.66
1301076	Adjustable Hanging Set on 100 x 100mm plates	610mm	£ 29.75
1301051	Adjustable Hanging Set	305mm	£ 25.21
1301072	Adjustable Hanging Set on 100 x 100mm plates	305mm	£ 28.29
1301014	Spring Latch Catch Set		£ 14.60
1301033	Self Locking Gate Catch (inc Striker)		£ 10.10
1301023	Chelsea Latch Set Stop Plate		£ 23.10
1301025	Chelsea Latch Set Thru Plate		£ 25.20
5001566	Round Garage Door Bolt	305mm	£ 9.70
5001567	Round Garage Door Bolt	457mm	£ 12.60
5001568	Round Garage Door Bolt	610mm	£ 14.00
1301044	Heavy Duty Drop Bolt		£ 26.93
1301037	Loopover Fastener	355mm	£ 5.99
1301140	Mortice latch Set		£ 18.74
1301019	Hooks on Plates 100mm x 100mm		£ 4.10
6007982	Coach Screws to suit above		£ 0.41
1301018	Hook to Build 229mm x 19mm		£ 6.03
1301080	Weighty Gate Stop in 75 x 75mm Post		£ 45.64

* Self colour available on certain items – Prices on request

* This is just a small selection of our comprehensive range.

Top Ride Hinge

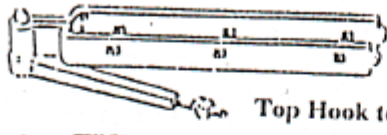

Top Hook to Bolt

Bottom Ride Hinge



Bottom Hook to Drive



Adjustable Bottom Fitting

Hook to Build in



Hook on 100mm x 100mm Plates

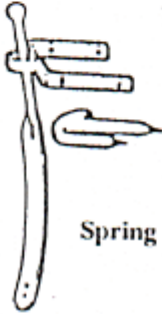

Spring Latch Catch & Keep

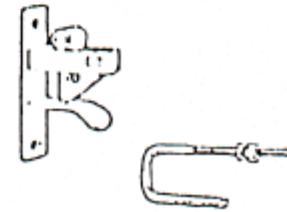

Self Locking Gate Catch



Chelsea Catch



Thru Plate



Stop Plate

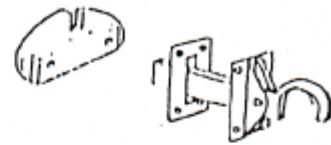

Mortice Latch



Round Garage Door Bolt

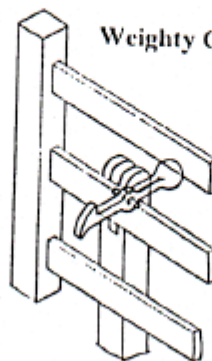

Weighty Gate Stop in 75 x 75mm Post

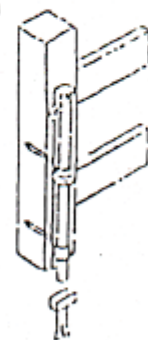

Heavy Duty Drop Bolt & Ground Socket (Pad lockable)



Loop Over Fastener